

Silicon Schottky Diode

BAS 70W

- General-purpose diodes for high-speed switching
- Circuit protection
- Voltage clamping
- High-level detection and mixing

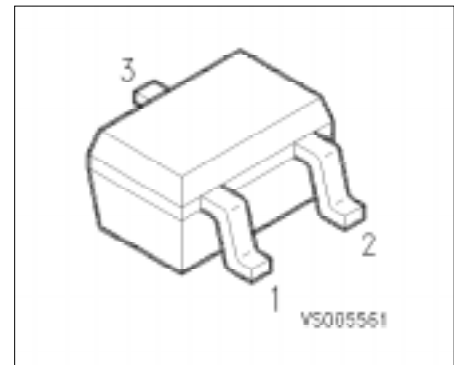

Type	Ordering Code (tape and reel)	Pin Configuration			Marking	Package ¹⁾
		1	2	3		
BAS 70-04W	Q62702-A1068	A1	C2	C1/A2	74s	SOT-323
BAS 70-05W	Q62702-A1069	A1	A2	C1/C2	75s	
BAS 70-06W	Q62702-A1070	C1	C2	A1/A2	76s	

Maximum Ratings

Parameter	Symbol	Values	Unit
Reverse voltage	V_R	70	V
Forward current	I_F	70	mA
Surge forward current, $t \leq 10$ ms	I_{FSM}	100	mA
Total power dissipation $T_S \leq 91$ °C	P_{tot}	250	mW
Operating temperature range	T_{op}	- 55 ... + 150	°C
Storage temperature range	T_{stg}	- 55 ... + 150	°C

Thermal Resistance

Junction-ambient ¹⁾	$R_{th JA}$	≤ 455	K/W
Junction-soldering point	$R_{th JS}$	≤ 235	K/W

1) Package mounted on an epoxy pcb 40 mm x 40 mm x 1.5 mm/1cm² Cu.

Electrical Characteristicsat $T_A = 25\text{ °C}$, unless otherwise specified.

Parameter	Symbol	Value			Unit
		min.	typ.	max.	
DC Characteristics					
Breakdown voltage $I_{(BR)} = 10\ \mu\text{A}$	$V_{(BR)}$	70	–	–	V
Forward voltage $I_F = 1\ \text{mA}$ $I_F = 10\ \text{mA}$ $I_F = 15\ \text{mA}$	V_F	300 600 750	375 705 880	410 750 1000	mV
Reverse current $V_R = 50\ \text{V}$ $V_R = 70\ \text{V}$	I_R	– –	– –	0.1 10	μA
Diode capacitance $V_R = 0\ \text{V}, f = 1\ \text{MHz}$	C_T	–	1.5	2	pF
Charge carrier life time $I_F = 25\ \text{mA}$	τ	–	–	100	ps
Differential forward resistance $I_F = 10\ \text{mA}, f = 10\ \text{kHz}$	r_f	–	34	–	Ω
Series inductance	L_S	–	2	–	nH

Forward current $I_F = f(V_F)$

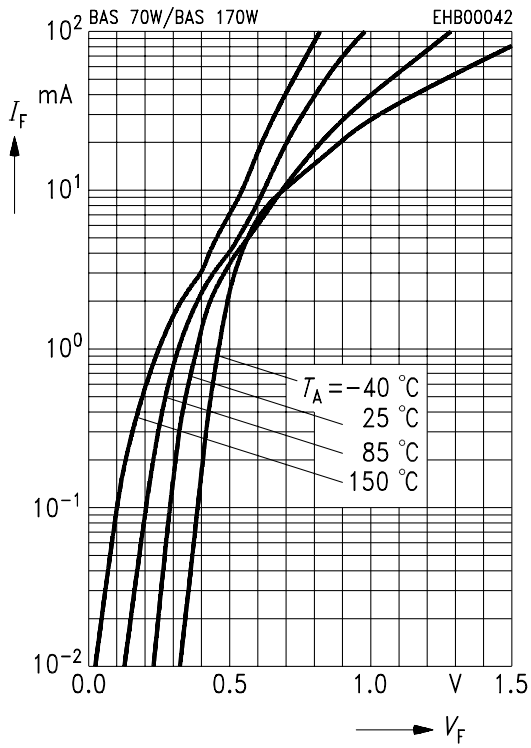

Reverse current $I_R = f(V_R)$

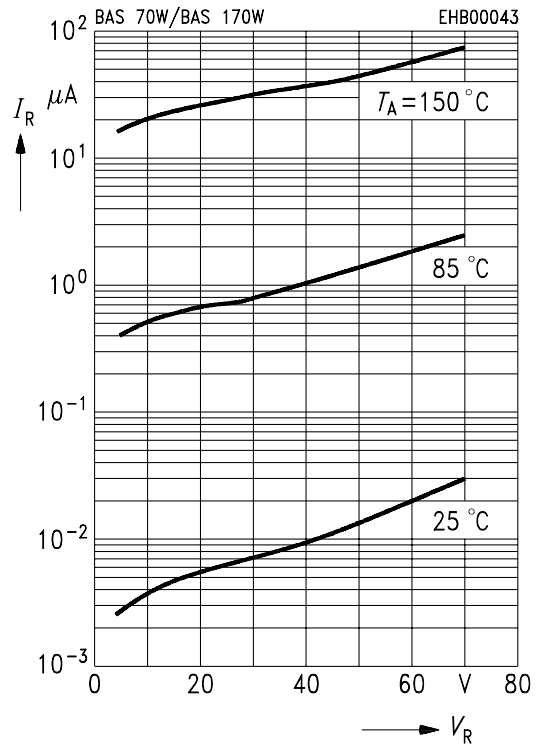

Diode capacitance $C_T = f(V_R)$

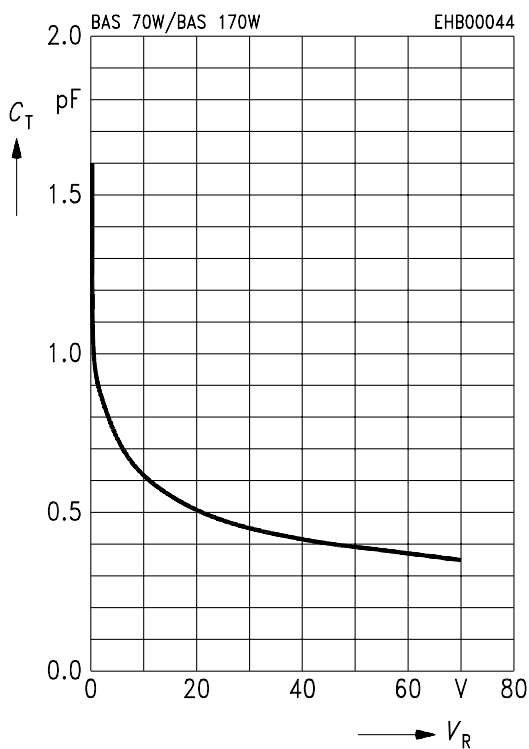

Differential forward resistance $R_F = f(I_F)$

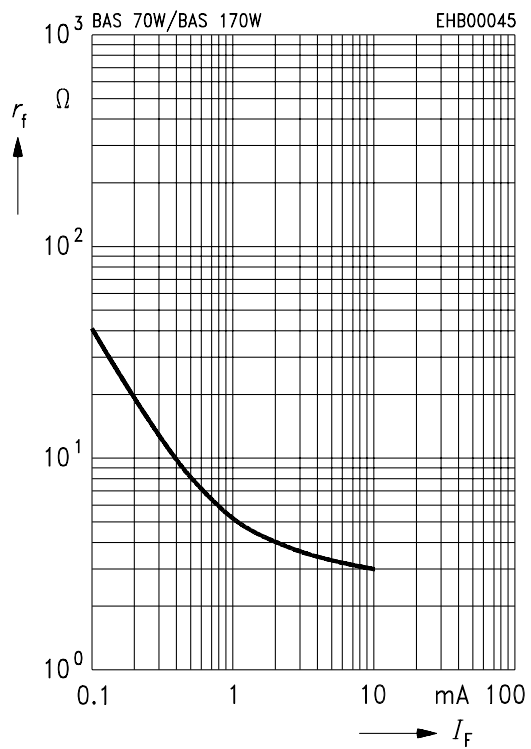

Permissible Pulse load $I_F = f(T_A; T_S^*)$

* Package mounted on epoxy

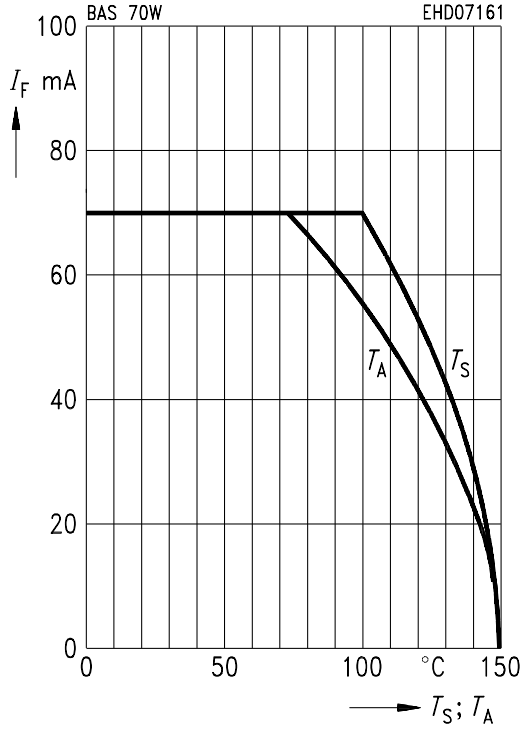

Permissible load $R_{thJS} = f(t_p)$

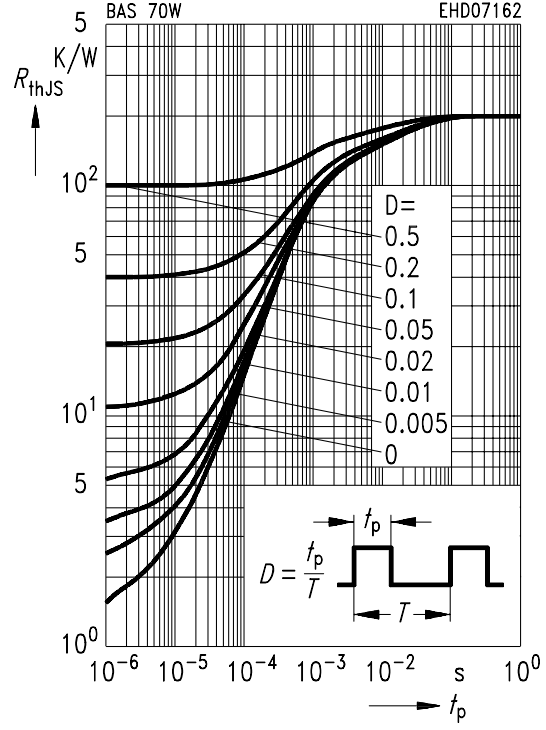

Permissible Pulse load $I_{Fmax} / I_{FDC} = f(t_p)$

